



**COMMERCIAL**

# CM40 & CM50 Series

Commercial Analogue Mobile Radios



## CONTENTS

<b>INTRODUCTION:</b>	<b>3</b>	<b>SETTINGS:</b>	<b>24</b>
Available Configurations .....	3	Alert Level .....	24
Key Features .....	3	Beep Level .....	25
Supplied Configurations .....	4	Key Tones .....	25
Controls .....	5	Channel Info .....	26
<b>GENERAL OPERATION:</b>	<b>7</b>	Display .....	26
Turning the Radio On/Off & Volume ...	7	Functions .....	27
Adjusting the Speaker Volume .....	7	Lock Radio .....	27
Selecting Channels .....	9	Squelch Level .....	28
Screen Display .....	9	TX Power .....	29
Display Symbols .....	9	Radio Info .....	29
LEDs .....	10	Change PIN .....	30
Tones .....	10	FW Version .....	30
<b>ADVANCED OPERATION:</b>	<b>11</b>	MDC/ Selcall ID .....	30
Channels .....	11	Serial Number .....	31
Zones .....	11	Speakers .....	31
Recent Calls .....	12	Main Speaker .....	32
Recent Messages .....	12	Auxiliary Speaker .....	32
Selcall .....	13	Lone Worker .....	32
Send DTMF .....	14	<b>DIAGNOSTICS:</b>	<b>34</b>
<b>SERVICES:</b>	<b>15</b>	Frequency .....	34
Send MSG .....	16	RSSI .....	35
Send Alert (Page) .....	17	<b>EMERGENCY MODES</b>	<b>35</b>
Send Status .....	18	<b>MENU TREE</b>	<b>36</b>
Set Status .....	19	<b>NOTICES &amp; WARNINGS</b>	<b>37</b>
Status Request .....	20	<b>POSTFACE</b>	<b>38</b>
Check Request .....	21	<b>WARRANTY</b>	<b>40</b>
Inhibit Request .....	22	<b>NOTES</b>	<b>42</b>
Uninhibit Request .....	23		

## INTRODUCTION

The CM40 and CM50 have been designed and made in Australia by GME Pty Ltd specifically to meet the requirements of commercial radio users.

Please read this user manual thoroughly. It provides information on the features, parts, controls and specifications of the CM40 and CM50 radios.

## AVAILABLE CONFIGURATIONS

The CM40 & CM50 Series radios can be purchased in the following configurations:

### **Standard Configuration (CM40 & CM50)**

The display is fitted to the radio and supplied with a MP600B Fist Microphone

**NOTE:** *The CM40 is sold in Standard Configuration only*

### **Remote Head Configuration (CM50)**

The display and controls are physically detached from the main base radio (Remote Head). The remote head is connected to a MP600B Fist Microphone as well as the main radio by the LE040 lead.

### **Controller Microphone Configuration (CM50)**

The base radio has no display or controls and is connected to a UIC600 Controller Microphone.

## KEY FEATURES

### **CM40 Series**

- 119 Private Channels
- 80 UHF CB/ PRS Channels
- 10 Zones
- 5 Watt Transmission Power
- 450-520 Mhz
- 5 Tone Selcall
- MDC1200 Compatible
- DTMF

### **CM50 Series**

- 2000 Channel Capacity
- Dealer Enabled 80 UHF CB/PRS Capable
- 50 Zones
- 25 Watt Transmission Power
- 450-520 MHz
- 5 Tone Selcall
- MDC1200 Compatible
- DTMF
- RSSI and Busy Voting

### CM40 Series:

#### Standard Configuration CM40-U5

- MP600B** Heavy Duty IP67 Fist Mic to suit CM & TX Series
- MB009** Mounting Bracket for CM & TX Series
- LE09** 1.8M DC Lead to suit 5W CM & TX Series

### CM50 Series:

#### Standard Configuration CM50-U25

- MP600B** Heavy Duty IP67 Fist Mic to suit CM & TX Series
- MB009** Mounting Bracket for CM & TX Series
- LE013** 3M DC Lead to suit 25W CM & TX Series

#### Remote Head Configuration CM50-U25R

- MP600B** Heavy Duty IP67 Fist Mic to suit CM & TX Series
- MB009** Mounting Bracket for CM & TX Series
- LE013** 3M DC Lead to suit 25W CM & TX Series
- LE040** RJ45 1.8m Extension Cable to suit AD008
- AD008** RJ45 Inline Joiner to suit LE040
- RH006** Remote Head with 1.8m Lead to suit CM50/ CM60 Series

#### Controller Microphone Configuration CM50-U25S

- MB009** Mounting Bracket for CM & TX Series
- LE013** 3M DC Lead to suit 25W CM & TX Series
- LE040** RJ45 1.8m Extension Cable to suit AD008
- AD008** RJ45 Inline Joiner to suit LE040
- UIC600** OLED Controller Microphone to suit CM50/ CM60 Series

## CONTROLS

The instructions below describe the locations and default functions of the controls on the fixed mount radio and microphones.

Each of these controls have been configured by your dealer for your application.

If required, please refer to your dealer for more detailed operating instructions relating to the specific programming of your radio.

Refer to the **Programmable Keys Control Functions** section of this manual for information on the control functions programmed in the radio by the dealer. The figures in this section show parts of the local and remote control head and fist microphone, and the functions assigned to the buttons.

### Radio Controls

Radio control functions can be assigned to programmable keys/ buttons in the standard & remote head configurations as well as the MP600B fist microphone. Each key can be programmed with a different function and activated by a single **Press or Hold**. A **Press** is less than one second and a **Hold** is more than one and a half seconds.

The following diagrams (Fig 1, Fig 2) show the location of the programmable keys/ buttons.

Refer to the **Programmable Keys Control Functions** section of this manual for information on the specific control functions programmed into the CM40/ CM50 radio by your commercial dealer.

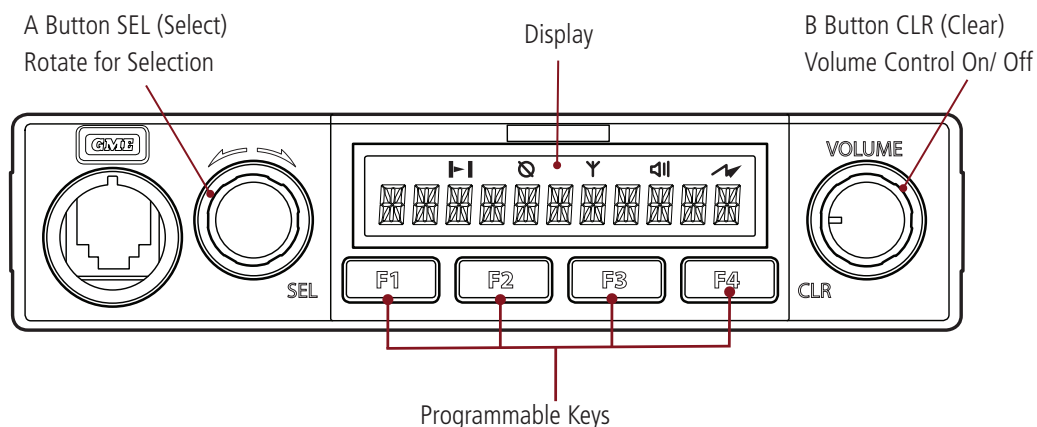

Figure 1: Standard and Remote Head Configurations

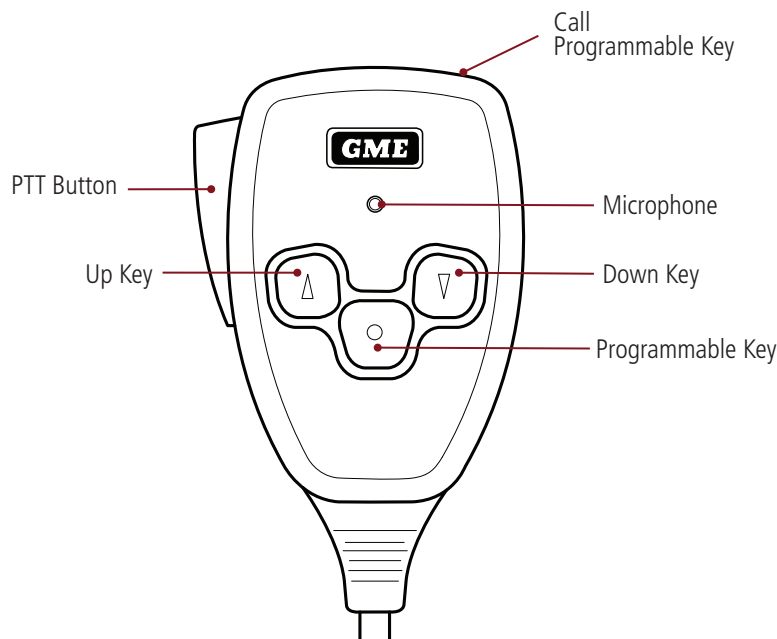

Figure 2: MP600B Fist Microphone

## UIC600 Microphone Controls

When using the UIC600 Controller Microphone, the CM50 base radio must be fitted with a remote-control panel. The front of the CM50 base radio will have no controls, the UIC600 controller microphone is connected into the socket and controls all functions of the CM50 radio through assigned keys/ buttons.

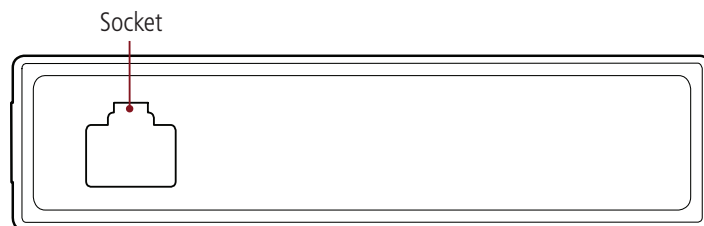

Figure 3: Remote Control Panel

**NOTE:** The **socket** on the remote control panel is only used with the controller microphone or the remote control head.

All control functions of the radio are assigned to keys/ buttons on the UIC600 controller microphone when the CM50 is fitted with a remote control panel.

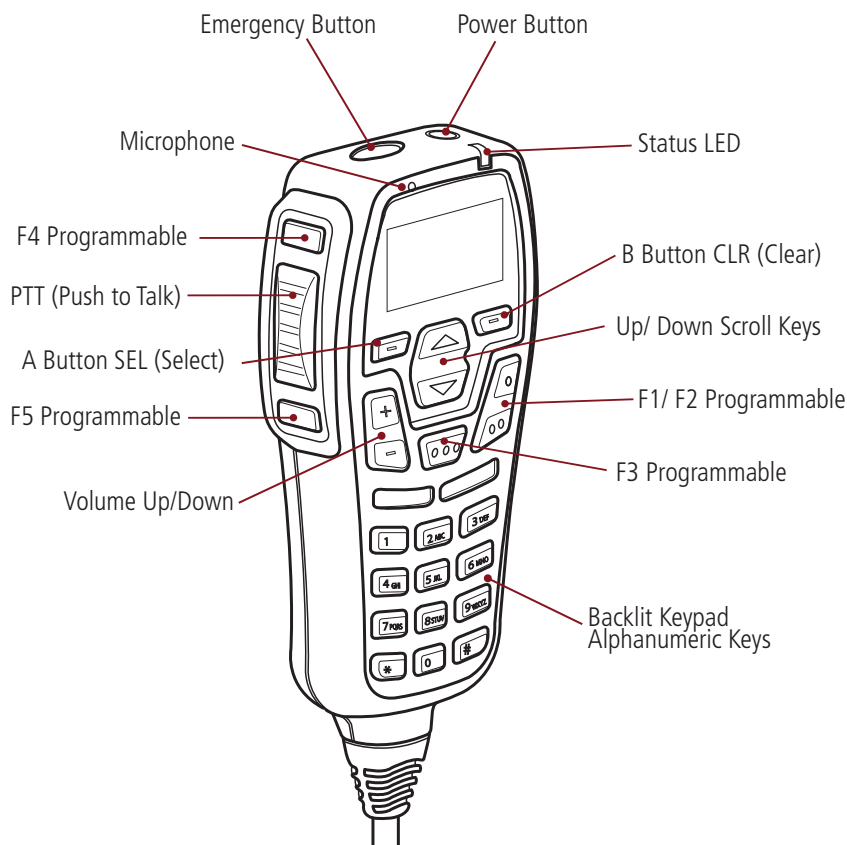

Figure 4: UIC600 Controller Microphone

## GENERAL OPERATION

Please refer to the diagrams on the **Controls** page for a general description of the controls and keys.

### PROGRAMMABLE KEYS:

The dealer can assign control functions to programmable keys on the radio. Contact the dealer or refer to the **Programmable Keys Control Functions** section of this manual for more information.

### Turning the Radio On/ Off & Volume

To turn the radio on using the control head, turn the **Volume Knob (B Button)** clockwise until it clicks. To turn radio off, turn volume knob anti-clockwise until it clicks.

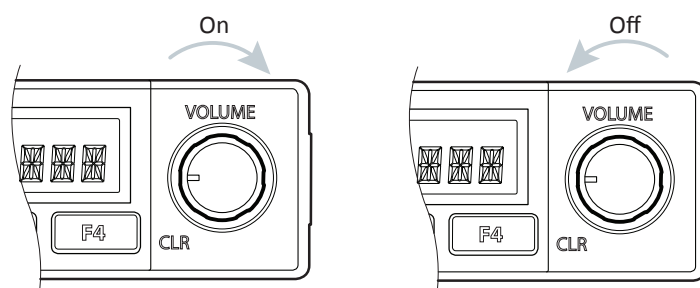

To turn radio on/ off using the controller microphone, press and hold the **Power Button** located on top of the microphone.

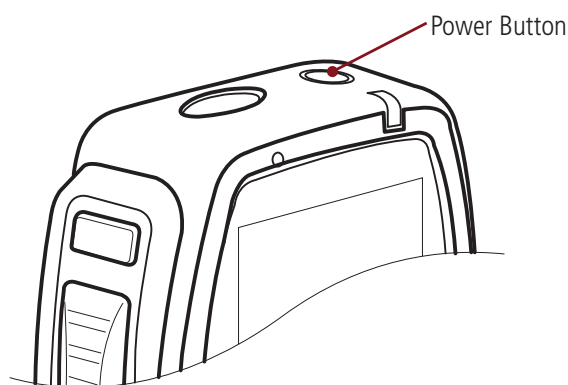

### Adjusting the Speaker Volume

To adjust the volume on local/ remote control head, turn the **Volume Knob (B Button)** clockwise to turn the volume up. Turn **Volume Knob (B Button)** anti-clockwise to turn the volume down.

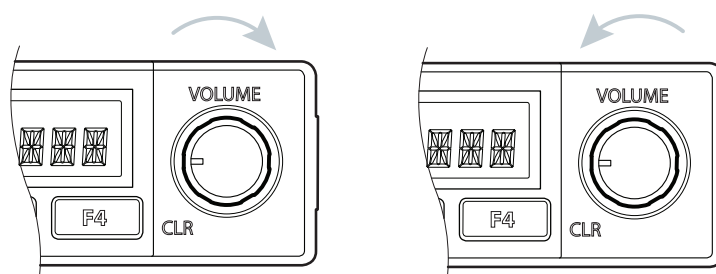

To adjust the volume on the UIC600 Controller Microphone use the **Up/ Down Volume Buttons**.



### Selecting Channels:

Local/ Control Head: **Select Channels** from the main menu, rotate the **A Button** (Channel Selector) to locate the desired channel then press the **Push-to-Talk** (PTT).

Controller Microphone: **Select Channels** from the main menu, use the **Up/ Down Arrows** to locate the desired channel then press the **Push-to-Talk** (PTT).

**NOTE:** Your dealer can program your radio to save individual channels to programmable keys for quick selection. Please refer to your dealer.



### Transmitting:



Before transmitting, check if the channel is already in use. If the channel is busy, wait until it is clear before transmitting.

1. Press and hold the **Push-to-Talk** (PTT) key. Hold the Fist Microphone or Controller Microphone 3-5 cms from your mouth and speak into the microphone at a normal voice level.
2. Release the **Push-to-Talk** (PTT) key when you have finished talking.

When transmitting, the  icon will appear on the local/controller and UIC Microphone display. In addition, the UIC Microphone status LED will be red.

### Receiving:

When receiving a signal, the  icon will appear on the local/controller and controller microphone display. The signal meter  icon will show the relative strength of the incoming signal (more bars indicates a stronger signal) in addition the controller microphone status LED will be Green. During this time the signal will be heard in the speaker.

If your radio is programmed to accept subtones on the selected channel and the incoming signal's subtone doesn't match yours, the  icon and the  icon will still appear on the local/controller and controller microphone display, the status LED will not light on the controller microphone and the speaker will remain quiet. This indicates the call was not meant for you.



## DISPLAY

The radio and the controller microphone displays the current menu and the status of the radio. When a menu is not accessed, the radio displays information such as the channel that is currently selected.

### Screen Display

The radio screen display on the local/ remote control head control.

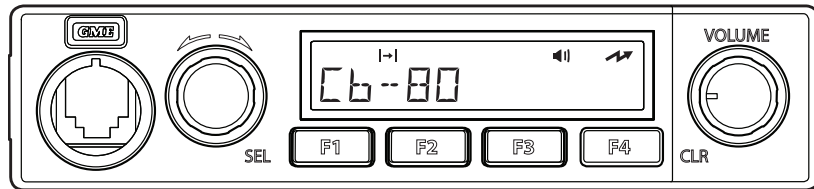





The screen display on the controller microphone.



### Display Symbols

Display symbols indicate the state and condition of the radio.

The table below describes display symbols of the radio and controller microphone.

Symbol	Meaning
	Signal strength indicator. The more bars, the stronger the signal being received. This symbol appears on the microphone controller only.
	The radio is transmitting.
	The radio is operating in repeater talkaround mode not using a repeater.
	A call is being received.

## LEDs

The controller microphone is fitted with an LED light that displays different colours depending on the radio status.

The table below explains the meaning of the LED light colours.

Colour	State/Action
Red	The radio is transmitting.
Green	The radio is receiving a call.
Orange	Emergency mode is active and the radio is not transmitting or receiving calls.
Purple	Radio is in programming mode.

## TONES

The radio uses audible tones to alert to its status. If tones are turned off no tones are audible.

For information on how to set the volume of tones refer to the **Navigating the Radio Menus** section in this manual.

The table below describes the tones and corresponding status of the radio.

State/Action	Tone
Generic 'successful' tone	2 Successive High Tones
Generic 'failure' tone	2 Falling Tones
Programmable key unavailable	2 Falling Tones
Key press, Selection made, Editing complete (can be disabled)	2 Successive High Tones
Enter Monitor Mode	2 Successive Mid Tones
Enter Emergency Mode	3 Successive High Tones
Incoming Emergency Call	3 Successive High Tones – Repeating
Exit Emergency Mode	2 Falling Tones
Clear Incoming Emergency Call	2 Falling Tones
Busy Lockout/ Call denied	2 Falling Tones
Message/ Status/ Call Alert received	1 High 1 Low Tone Repeating
Message/ Status/ Call Alert sent	2 Successive High Tones
Message/ Status/ Call Alert send failed	2 Falling Tones
Transmit timeout warning	2 Successive Mid-Tones 10sec Prior Time-Out
Transmit timeout active (repeating every second)	2 Falling Tones

## START UP DISPLAY

The screen will display the last selected channel. Press the **A Button** to access the main menu.

## Channels

A channel contains frequencies the radio uses to transmit and receive signals. The **Channels** menu displays a list of channels that are available in the currently selected zone.

To access the **Channels** menu:

1. Select **Channels** from the main menu.
2. Press the **A Button** to select **Channels** or the **B Button** to go back to the previous menu.

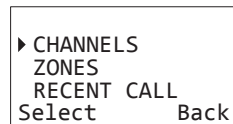

*UIC600 Microphone Display*



*Radio Display*

To scroll through the **Channels** list:

- Use the **Up/ Down Arrows** on the controller microphone.
- Turn the **A Button (Selector Knob)** on the local head.

Press the **A Button** to select a particular channel and return to the main menu. Press the **B Button** to go back to the previous menu.

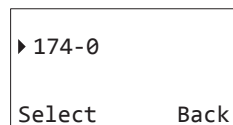

*UIC600 Microphone Display*



*Radio Display*

## Zones

A zone can contain a group of channels. The CM40 supports up to 10 zones. The CM50 supports up to 50 zones.

To access the **Zones** menu:

1. Scroll to **Zones** from the main menu.
2. Press the **A Button** to select **Zones**. Press the **B Button** to go back to the previous menu.

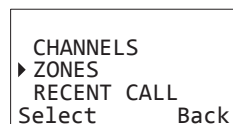

*UIC600 Microphone Display*



*Radio Display*

To scroll through the **Zone** list:

- Use the **Up/ Down Arrows** on the controller microphone.
- Turn the **A Button (Selector Knob)** on the local head.

Press the **A Button** to select a particular **zone** and return to the main menu. Press the **B Button** to go back to the previous menu.

## Recent Calls

---

This feature lists the 20 most recent calls made, received or missed by displaying the corresponding Call ID or Unit ID. The most recent call is displayed first on the list. Select a Call/ Unit ID on this list to call back.

To access the **Recent Calls** menu:

1. Scroll to **Recent Calls** on the main menu.
2. Press the **A Button** to select **Recent Calls**. Press the **B Button** to go back to the previous menu.

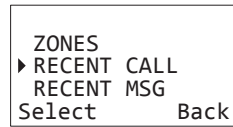

*UIC600 Microphone Display*



*Radio Display*

To scroll through the **Recent Call** list:

- Use the **Up/ Down Arrows** on the controller microphone.
- Turn the **A Button (Selector Knob)** on the local head.

Press the **A Button** to call back. Press the **B Button** to go to the previous menu.

## Recent Messages

---

This feature shows the ten most recent messages that were sent or received. The most recent message is displayed first on the list.

To access the **Recent Messages** menu:

1. Select **Recent Messages** from the main menu.
2. Press the **A Button** to select **Recent Messages**. Press the **B Button** to go back to the previous menu.

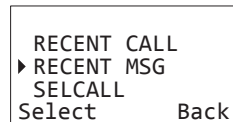

*UIC600 Microphone Display*



*Radio Display*

To scroll through the **Recent Messages** list:

- Use the **Up/ Down Arrows** on the controller microphone.
- Turn the **A Button (Selector Knob)** on the local head.

Press the **B Button** to go back to the previous menu.

## Selcall (Selective Calling)

**Selective Calling** is an analog signaling technology which operates like a telephone where a call to a specific radio uses the custom unique ID of the radio. **SelCall** supports 48 unique idents, with up to 11 characters of alpha text to be displayed.

To access the **Selcall** menu:

1. Scroll to **Selcall** on the main menu.
2. Press the **A Button (Selector Knob)** to select **Selcall**, or the **B Button** to go back to the previous menu.

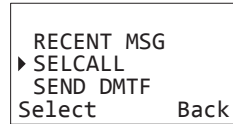

*UIC600 Microphone Display*



*Radio Display*

To scroll through the **Selcall** list:

- Use the **Up/ Down Arrows** on the controller microphone.
- Turn the **A Button (Selector Knob)** on the local head.

The SelCall menu displays a list of all SelCall contacts in the contact book. The first item in the list is ENTER ID.

To enter a **Custom ID** and to initiate a **Selcall** on the controller microphone:

1. Press the **A Button** to select Enter ID.
2. Enter the ID using the alphanumeric keypad.
3. Press the **A Button** to initiate the Selcall.

To enter a **Custom ID** and to initiate a **Selcall** on the Local/ Remote Control Head:

1. Press the **A Button** to select Enter ID.
2. Turn the **A Button (Selector Knob)** to change the value of the selected digit.
3. Press the **A Button** to move between selected digits.
4. Press and hold the **A Button** to initiate a Selcall.

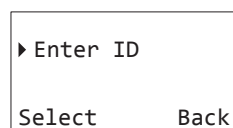

*UIC600 Microphone Display*



*Radio Display*

To select a predefined **Selcall**:

1. Press the **Up/ Down Arrows** on the UIC600 or rotate the **A Button (Selector Knob)** on the local head.
2. Press the **A Button** to accept and send the call. Press the **B Button** to go back.

The radio can be put in quiet mode. Incoming transmissions are muted until the radio receives a matching **Selective Call (SelCall)** when the radio is in quiet mode.

## Send DTMF

**DTMF** (Dual Tone Multiple Frequency) is an analog signaling system used to connect to a telephone network by a telephone interconnect device. The **Send DTMF** option sends a predefined string of DTMF tones for keying up a repeater.

DTMF supports 15 unique tone sequences of up to 16 tones each. Up to 11 characters of alpha text will be displayed.

To access the **Send DTMF** menu:

1. Select **Send DTMF** from the main menu.
2. Press the **A Button** to select or the **B Button** to go back to the previous menu.



*UIC600 Microphone Display*



*Radio Display*

The first item in the list is **Enter DTMF**.



*UIC600 Microphone Display*



*Radio Display*

To initiate a call using a **Custom DTMF** string on the controller microphone:

1. Press the **A Button** to select **Enter DTMF**.
2. Use the numeric keypad to enter a phone number.
3. Press the **A Button** to initiate a **DTMF** call and return to the main screen.

To initiate a call using a **Custom DTMF** string on the local/remote control head:

1. Turn the **A Button (Selector Knob)** to select a digit if **Enter DTMF** is selected.
2. Press the **A Button** to enter the next digit.
3. When the entire number is entered, press and hold the **A Button** to initiate the call.

To initiate a call using a **Predefined DTMF** string on the UIC600 controller microphone:

1. Select the **DTMF** menu. The first item in the list is **Enter DTMF**.
2. Press the **Down Key** to select string. Press the **A Button** to initiate call.

To initiate a call using a **Predefined DTMF** string on the local/remote control head:

1. Select the **DTMF** menu. The first item in the list is **Enter DTMF**.
2. Turn the **A Button (Selector Knob)** to select a string.
3. Press the **A Button** to initiate call.

## SERVICES

The **Services** menu becomes available only if Digital Selcall is enabled. Digital Selcall (MDC1200) is a digital signalling technology that is used for analog channels. The CM40 and CM50 series programming manual contains information on configuring the radio to use digital selcall.

Services provide features that are listed and described in the table below.

Feature	Detail	Description
<i>SEND MSG</i>	Send Message	Provides list of predefined short messages that can be sent to another radio.
<i>SEND ALERT</i>	Send Alert	Sends page alert call to another radio user alerting them that you want to talk to them.
<i>SEND STATUS</i>	Send Status	Predefined status messages used to inform another radio of your current status.
<i>SET STATUS</i>	Set Status	Allows you to select and set a status message indicating your current status.
<i>STATUS REQ</i>	Status Request	Allows you to send a signal to another radio requesting a status update.
<i>CHECK REQ</i>	Check Request	Sends a radio check message to confirm whether a radio is within communication range.
<i>INHIBIT REQ</i>	Inhibit Request	Sends a request to prevent a radio from transmitting. Also known as stun.
<i>UNINHIBIT REQ</i>	Uninhibit Request	Sends a request to stop preventing a radio from transmitting. Also known as revive.

To access the **Services** menu:

Select **Services** from the main menu.

Press the **A Button** to select or the **B Button** to go back to the previous menu.

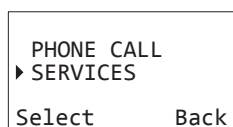

*UIC600 Microphone Display*



*Radio Display*

The following sections explain each of the **Services** features in detail.

## Send MSG

---

The **Send MSG** (Send Message) feature provides a list of predefined short messages that can be broadcast to other radio operators to indicate an event or make a request.

To access the **Send MSG** menu:

1. Select **Services** from the main menu.
2. Select **Send MSG**.
3. Press the **A Button** to select, or the **B Button** to go back. If there are no predefined messages programmed to the radio the screen will display **INVALID**.

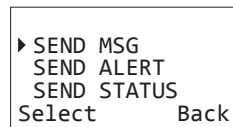

*UIC600 Microphone Display*

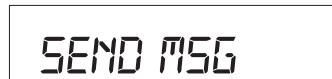

*Radio Display*

To broadcast a Message on the UIC600 controller microphone:

1. Press the **Up/ Down Arrows** to select a predefined message.
2. Press the **A Button** to send the message.

To broadcast a Message on the local/ remote control head:

1. Turn the **A Button (Selector Knob)** to select a predefined message.
2. Press the **A Button** to send the message.

The radio displays **MSG SENT** when a receiving radio or console sends a message acknowledgement in response. **MSG FAILED** will be shown if no acknowledgement is received within 5 seconds.



## Send Alert (Page)

---

The **Send Alert** feature allows for an alert to be sent to another radio requesting communication.

To access the **Send Alert** menu:

1. Select **Services** from the main menu.
2. Select **Send Alert**.
3. Press the **A Button** to select or the **B Button** to go back.

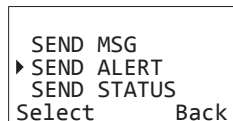

```
SEND MSG
▶ SEND ALERT
SEND STATUS
Select      Back
```



```
SEND ALERT
```

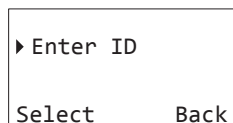

```
▶ Enter ID
Select      Back
```



```
ENTER ID
```

*UIC600 Microphone Display*

*Radio Display*

To **Send Alert** to a custom radio ID on the controller microphone:

1. Press the **A Button** to select.
2. Enter the radio ID using the numeric keypad.
3. Press the **A Button** to initiate the page alert.

To **Send Alert** to a custom radio ID on the local/ remote control head:

1. Press the **A Button** to select Enter ID.
2. Turn the **A Button (Selector Knob)** to select a digit. Press the **A Button** to enter the next digit.
3. Enter the entire number. Press and hold the **A Button** to send the page alert.

To **Send Alert** to a predefined radio ID on the UIC controller microphone:

1. Press the **Up/ Down Arrows** to select a predefined radio ID.
2. Press the **A Button** to send the page alert.

To **Send Alert** to a predefined radio ID on the local/ remote control head:

1. Turn the **A Button (Selector Knob)** to select a predefined radio ID.
2. Press the **A Button** to send the page alert.
3. The radio displays **ALERT SENT** after the receiving radio has received the page alert.

## Send Status

---

The **Send Status** feature provides a list of predefined status messages that can be broadcast to other radio operators to inform them of the user's current status.

To access the **Send Status** menu:

1. Select **Services** from the main menu.
2. Select **Send Status**.
3. Press the **A Button** to select, or the **B Button** to go back. If there are no predefined status programmed to the radio the screen will display *INVALID*.



*UIC600 Microphone Display*



*Radio Display*

To broadcast a Status on the UIC600 controller microphone:

1. Press the **Up/ Down Arrows** to select a predefined status.
2. Press the **A Button** to send the status.

To broadcast a Status on the local/ remote control head:

1. Turn the **A Button (Selector Knob)** to select a predefined status.
2. Press the **A Button** to send the status.

The radio displays *STS SENT* when a receiving radio or console sends a status acknowledgement in response. *STS FAILED* will be shown if no acknowledgement is received within 5 seconds.

## Set Status

The **Set Status** option allows selection and setting a status message that indicates the radio's current status. The selected message remains set in the radio until updated with another message. When the radio receives a status request message it will reply by broadcasting the currently stored status, allowing other users to query the radio's current status. The **Set Status** option also allows access to a list of predefined status messages in the radio.

To access the **Set Status** menu:

1. Select **Services** from the main menu.
2. Select **Set Status**.
3. Press the **A Button** to select or the **B Button** to go back.

The Set Status option is displayed only when the Status Message feature is enabled in the radio.



*UIC600 Microphone Display*



*Radio Display*

To **Set Status** on the UIC600 controller microphone:

1. Press the **Up/ Down Arrows** and select **Set Status**.
2. Select the status message and then press the **A Button** (Select).

To **Set Status** on the local/ remote control head:

1. Turn the **A Button** (Selector Knob) to select **Set Status**.
2. Turn the **A Button** (Selector Knob) to select the message.
3. Press the **A Button** to set the status message.
4. The radio will display **STATUS SET** when the message is set.

## Status Request

The **Status Request** option allows a signal to be sent to another radio asking for a status update. The **Status Request** option allows access to a list of predefined radio IDs to send a request to.

To access the **Set Request** menu:

1. Select **Services** from the main menu.
2. Select **Status Request**.
3. Press the **A Button** to select or the **B Button** to go back.



4. The first item displayed is **Enter ID** if **Status Req** is selected.

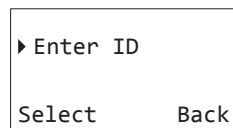

*UIC600 Microphone Display*

*Radio Display*

5. Press the **A Button** to select and the **B Button** to go back to the previous menu.

To send **Status Request** to a custom radio ID on the UIC600 controller microphone:

1. Press the **A Button**.
2. Enter the radio ID using the numeric keypad.
3. Press the **A Button** to send the status request.

To send **Status Request** to a custom radio ID on the local/ remote control head:

1. Press the **A Button** to select Enter ID.
2. Turn the **A Button (Selector Knob)** to select the first digit for the ID. Next, press the **A Button** to enter the next digit.
3. Press and hold the **A Button** to send the status request when the entire ID has been entered

To send **Status Request** to a predefined radio ID on the UIC600 controller microphone:

1. Press the **Up/ Down Arrows** to select a predefined radio ID.
2. Press the **A Button** to send the status request.
3. **STATUS RCVD** is displayed after the recipient radio has received the status request.
4. Press the **A Button** to view status of the recipient radio and the **B Button** to exit.

To send **Status Request** to a predefined radio ID on the local/ remote control head:

1. Turn the **A Button (Selector Knob)** to select a predefined radio ID.
2. Press the **A Button** to send the status request.
3. **STATUS RCVD** is displayed after the recipient radio has received the status request.
4. Press the **A Button** to view status of the recipient radio and the **B Button** to exit.

## Check Request

---

The **Check Request** feature sends a radio check message to confirm whether a radio is within communication range.

To access the **Check Request** menu:

1. Select **Services** from the main menu.
2. Select **Check Request**.
3. Press the **A Button** to select or the **B Button** to go back. The first item displayed is **ENTER ID** if **Check Request** is selected.
4. Press the **A Button** to select and the **B Button** to go back to the previous menu.

To send **Check Request** to a custom radio ID on the controller microphone:

1. Press the **A Button**.
2. Enter the radio ID using the numeric keypad.
3. Press the **A Button** to send the **Check Request**.

To send **Check Request** to a custom radio ID on the local/remote control head:

1. Press the **A Button** to select Enter ID.
2. Turn the **A Button** to select the first digit for the ID. Next, press the **A Button** to enter the next digit.
3. When the entire ID is entered, press and hold the **A Button** to send the check request.

To send **Check Request** to a predefined radio ID on the controller microphone:

1. Press the **Up/ Down Arrows** to select a predefined radio ID.
2. Press the **A Button** to send the check request.

To send **Check Request** to a predefined radio ID on the local/remote control head:

1. Turn the **A Button (Selector Knob)** to select a predefined radio ID.
2. Press the **A Button** to send the **Check Request**.
3. The message **SUCCESS** is displayed if the radio is available on the system. Press the **A Button** to accept and the **B Button** to delete.



SUCCESS

*Radio Display*

## Inhibit Request

---

A radio that is configured with this feature can send an **Inhibit Request** that prevents a selected radio from operating. The **Inhibit Request** feature may also be known as Stun.

To access the **Inhibit Request** menu:

1. Select **Services** from the main menu.
2. Select **Inhibit Request**.
3. Press the **A Button** to select or the **B Button** to go back. The first item displayed is Enter ID if **Inhibit Request** is selected.

To send **Inhibit Request** to a custom radio ID on the controller microphone:

1. Press the **A Button**.
2. Enter the radio ID using the numeric keypad.
3. Press the **A Button** to send the **Inhibit Request**.

To send inhibit request to a custom radio ID on the local/ remote control head:

1. Press the **A Button** to select Enter ID.
2. Turn the **A Button (Selector Knob)** to select the first digit for the ID. Next, press the **A Button** to enter the next digit.
3. When the entire ID is entered, press and hold the **A Button** to send the **Inhibit Request**.

To send **Inhibit Request** to a predefined radio ID on the controller microphone:

1. Press the **Up/ Down Arrows** to select a predefined radio ID.
2. Press the **A Button** to send the **Inhibit Request**.

To send **Inhibit Request** to a predefined radio ID on the local/remote control head:

1. Turn the **A Button (Selector Knob)** to select a predefined radio ID.
2. Press the **A Button** to send the **Inhibit Request**.

## Uninhibit Request

---

A radio that is configured for this feature can send an **Uninhibit Request** to an inhibited radio allowing it to resume operation. The **Uninhibit Request** feature may also be known as Revive.

To access the **Uninhibit Request** menu:

1. Select **Services** from the main menu.
2. Select **Uninhibit Request**.
3. Press the **A Button** to select or the **B Button** to go back. The first item displayed is ENTER ID if **Uninhibit Request** is selected.
4. Press the **A Button** to select and the **B Button** to go back to the previous menu.

To send **Uninhibit Request** to a custom radio ID on the controller microphone:

1. Press the **A Button**.
2. Enter the radio ID using the numeric keypad.
3. Press the **A Button** to send the **Uninhibit Request**.

To send **Uninhibit Request** to a custom radio ID on the local/remote control head:

1. Press the **A Button** to select Enter ID.
2. Turn the **A Button (Selector Knob)** to select the first digit for the ID. Press the **A Button** to enter the next digit.
3. When the entire ID is entered, press and hold the **A Button** to send the **Uninhibit Request**.

To send an **Uninhibit Request** to a predefined radio ID on the controller microphone:

1. Press the **Up/ Down Arrows** to select a predefined radio ID.
2. Press the **A Button** to send the **Uninhibit Request**.

To send an **Uninhibit Request** to a predefined radio ID on the On local/remote control head:

1. Turn the **A Button (Selector Knob)** to select a predefined radio ID.
2. Press the **A Button** to send the **Uninhibit Request**.
3. **UNINHIBIT SENT** is displayed after an **Uninhibit Request** message is sent.

## SETTINGS

The **Settings** option contains a list of options that can be set for the radio.

To access the **Settings** menu:

1. Select **Settings** from the main menu.
2. Press the **A Button** to select or the **B Button** to go back to the previous menu.



*UIC600 Microphone Display*



*Radio Display*

The Settings menu displays the following options:

- Alert Level
- Channel Info
- Display
- Functions
- Radio Info
- Speakers

### Alert Level

---

The **Alert Level** setting allows you to set the audio output level of a beep.

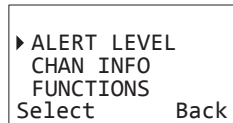

*UIC600 Microphone Display*



*Radio Display*

1. Press the **A Button** to select and the **B Button** to go back to the previous menu.
2. The setting has two options, **Beep Level** and **Key Tones**.



## Beep Level

---

The **Beep Level** option allows you to set the level of the beep tone.

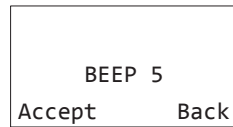

*UIC600 Microphone Display*

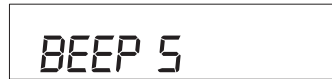

*Radio Display*

To access the **Beep** Level:

1. Select **Settings** from the main menu
2. Select **Alert Level**.
3. Select **Beep Level**.

To set the beep tone level:

1. Turn the **A Button (Selector Knob)** on the local head to scroll through different levels. Use the **Up/ Down Arrows** on the controller microphone.
2. Set the beep tone level by choosing a tone level between **BEEP 0** and **BEEP 9**.
3. Press the **A Button** to select and to return to the **Alert Level** menu. Press the **B Button** to return the beep level to its initial level and return to the **Alert Level** menu.

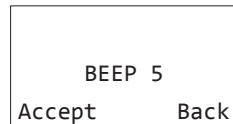

*UIC600 Microphone Display*

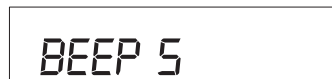

*Radio Display*

## Key Tones

---

The **Key Tones** feature allows you to set the alert key tones.

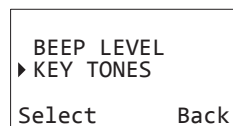

*UIC600 Microphone Display*



*Radio Display*

To access **Key Tones**:

1. Select **Setting** from the main menu.
2. Select **Alert Level**.
3. Select **Key Tones**.

To set/change the alert key tone:

1. Turn the **A Button (Selector Knob)** on the local head. Use the **Up/ Down Arrows** on the controller microphone to scroll through the on/ off options.
2. Press the **A Button** to turn the key tones off or on by choosing either option and return to the **Alert Level** menu.
3. Press the **B Button** to leave the key tone unchanged and return to the **Alert Level** menu.

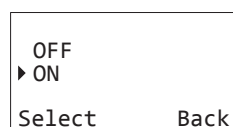

*UIC600 Microphone Display*



*Radio Display*

## Channel Info

---

The **Channel Info** displays the configuration information for the set channel.

1. Press the **A Button** to access the menu.

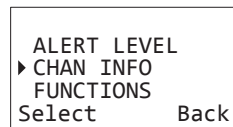

*UIC600 Microphone Display*

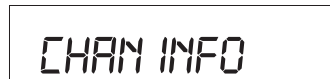

*Radio Display*

2. Use the **A Button (Selector Knob)** on the local head, or the **Up/ Down Arrows** on the controller microphone to scroll the information on the display.

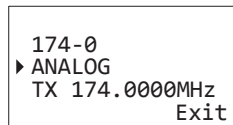

*UIC600 Microphone Display*



*Radio Display*

3. Press the **B Button** to exit the menu.

## Display

---

The Display option allows the backlight brightness for the radio display to be set. The option is available for the local and remote setup only.

The controller microphone automatically adjusts the backlight.

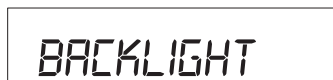

*Radio Display*

To set the **Backlight Brightness**:

1. Turn the **A Button (Selector Knob)** on the local head to scroll through different levels.
2. Set the **Brightness** level by choosing a level between **BKLG1 1** and **BKLG1 16**.
3. Press the **A Button** to select and to return to the **Display** menu. Press the **B Button** to leave initial brightness level unchanged, and return to the **Backlight** menu.



*Radio Display*

## Functions

The **Functions** menu allows access to functions such as **Locking the Radio**, **Squelch Level** and **Transmission Power**.

To access the **Functions** menu:

1. Select **Settings** from the main menu.
2. Select **Functions**.

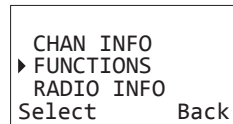

*UIC600 Microphone Display*



*Radio Display*

This setting has the following options:

- Lock Radio
- Squelch Level
- TX Power

## Lock Radio

The **Lock Radio** feature allows the radio to be locked.

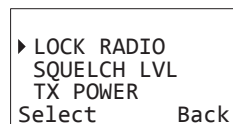

*UIC600 Microphone Display*



*Radio Display*

To **Lock** the radio on the controller microphone:

1. Select **Settings** from the main menu.
2. Select **Functions**.
3. Select **Lock Radio**. The screen displays the message **LOCK?**.
4. Press the **A Button** to lock the radio. The lock details are displayed on the screen.

To **Lock** the radio on the local/remote control head:

1. Select **Settings** from the main menu.
2. Select **Functions**.
3. Select **Lock Radio**. The screen displays the message **LOCK**.
4. Press the **A Button** to lock the radio. The locked details are displayed on the screen.

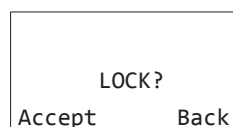

*UIC600 Microphone Display*



*Radio Display*

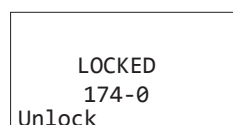

*UIC600 Microphone Display*



*Radio Display*

To **Unlock** the radio:

1. Press the **A Button** to access the Unlock option.
2. Press the **A Button** again to unlock the radio. The radio may require a **PIN** to unlock if configured for **PIN** entry.

For information on how to change the **PIN**. Refer the **Change PIN** section of this manual.

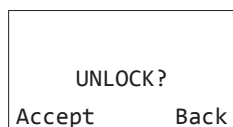

UIC600 Microphone Display



Radio Display

## Squelch Level

**Squelch** is used to eliminate any unwanted background noise when there are no signals present. The **Squelch Level** option allows the squelch level to be set. Squelch level 1 allows the squelch to open on very weak signals, whereas squelch level 9 requires much stronger signals to overcome the squelch.

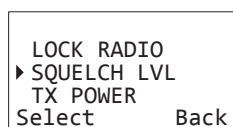

UIC600 Microphone Display



Radio Display

To access **Squelch Level**:

1. Select **Settings** from the main menu.
2. Select **Functions**.
3. Select **Squelch Level**.

To set the **Squelch Level**:

1. Turn the **A Button (Selector Knob)** on the local head, use the **Up/ Down Arrows** on the controller microphone to scroll through different squelch levels.
2. Set the **Squelch Level** by choosing a level between **SQL 1** and **SQL 9**.
3. Press the **A Button** to select and the **B Button** to go back to the **Squelch Level** menu.

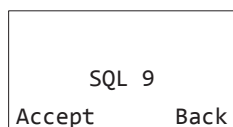

UIC600 Microphone Display



Radio Display

## TX Power

---

The **TX Power** option allows you to set the radio's maximum transmission power level.

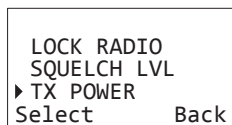

*UIC600 Microphone Display*



*Radio Display*

To access **TX Power**:

1. Select **Settings** from the main menu.
2. Select **Functions**.
3. Select **TX Power**.

To set the **TX Power** level:

1. Turn the **A Button (Selector Knob)** on the local head to scroll through different **TX POWER** levels. Press the **Up/ Down Arrows** on the controller microphone.
2. Set the transmission power level by choosing between **TX 1W**, **TX 5W**, **TX 10W** (CM50 Only) and **TX 25W** (CM50 Only).
3. Press the **A Button** to select and the **B Button** to go back to the previous menu.

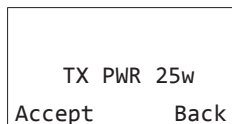

*UIC600 Microphone Display*



*Radio Display*

## Radio Info (Radio Information)

---

The **Radio Info** option allows the radio configuration information to be set.



*UIC600 Microphone Display*



*Radio Display*

Press the **A Button** to select and the **B Button** to go back to the previous menu.

The setting has the following options:

- Change PIN
- FW Version
- MDC/Selcall ID
- Serial Number

## Change PIN

---

The **Change PIN** option allows the PIN used to lock and unlock the radio to be changed.

To access **Change PIN**:

1. Select **Settings** from the main menu.
2. Select **Radio Info**.
3. Select **Change PIN**.
4. The screen displays the message *ENTER PIN*.

To change the **PIN** on the controller microphone:

1. Enter the new **PIN** and press the **A Button**.

To change the **PIN** on the local/remote control head:

1. Press the **A Button** to select *ENTER PIN*.
2. Turn the **A Button (Selector Knob)** to select the first digit for the new **PIN**.
3. Press the **A Button** to enter the next digit. Enter the entire **PIN**.
4. Press and hold the **A Button** to change the **PIN**.

## FW Version (Firmware Version)

---

The **FW Version** option displays the current firmware version installed on the radio.

To access **FW Version**:

1. Select **Settings** from the main menu.
2. Select **Radio Info**.
3. Select **FW Version**.

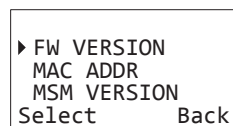

*UIC600 Microphone Display*



*Radio Display*

4. Press the **A Button** to select and the **B Button** to go back to the previous menu.

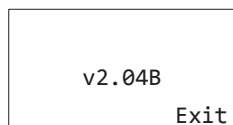

*UIC600 Microphone Display*



*Radio Display*

5. Press the **B Button** to exit this menu.

## MDC/ Selcall ID

---

The **MDC/ Selcall ID** menu displays the radio's configured Selcall ID (when a Selcall channel is selected) or MDC ID (when an MDC channel is selected).

To access **MDC/ Selcall ID**:

1. Select **Settings** from the main menu.
2. Select **Radio Info**.
3. Select **MDC/ Selcall ID**.

## Serial Number

---

The **Serial Number** option displays the radio's serial number.

To access **Serial No**:

1. Select **Settings** from the main menu.
2. Select **Radio Info**.
3. Select **Serial No**.

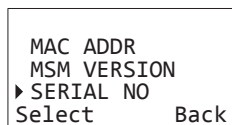

*UIC600 Microphone Display*



*Radio Display*

4. Press the **A Button** to select and the **B Button** to go back to the previous menu.

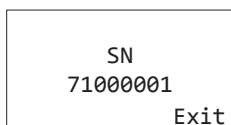

*UIC600 Microphone Display*



*Radio Display*

5. Press the **B Button** to exit this menu.

## Speakers

---

The **Speakers** feature allows you to mute or unmute speakers on the radio.

To access **Speakers**:

1. Select **Settings** from the main menu.
2. Select **Speakers**.



*UIC600 Microphone Display*



*Radio Display*

The options available are:

- MAIN SPK (Main speaker)
- AUX SPK (Auxiliary speaker)

## Main Speaker

---

To access **Main Speaker**:

1. Select **Settings** from the main menu.
2. Select **Speakers**.
3. Select **Main Spk**.

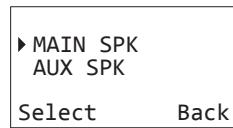

*UIC600 Microphone Display*



*Radio Display*

To set the **Mute/Unmute Main Speaker**:

1. Press the **A Button** to select **MUTE** to mute main speaker.
2. Select **UNMUTE** to unmute the speaker.
3. Press the **B Button** to go back to the previous menu.

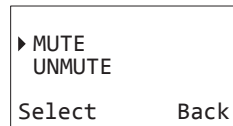

*UIC600 Microphone Display*



*Radio Display*

## Auxiliary Speaker

---

To access **Auxiliary Speaker**:

1. Select **Settings** from the main menu.
2. Select **Speakers**.
3. Select **Aux Spk**.

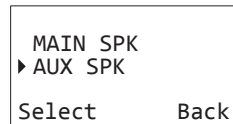

*UIC600 Microphone Display*



*Radio Display*

To set the **Mute/Unmute Auxiliary Speaker**:

1. Press the **A Button** to select **MUTE** to mute the auxiliary speaker.
2. Select **UNMUTE** to unmute the speaker.
3. Press the **B Button** to go back to the previous menu.

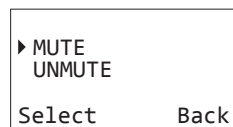

*UIC600 Microphone Display*



*Radio Display*

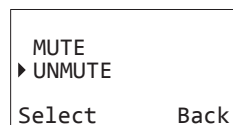

*UIC600 Microphone Display*



*Radio Display*



## Lone Worker

---

To access **Lone Worker**:

1. Select **Settings** from the main menu.
2. Select **Lone Worker**.

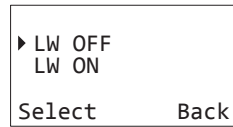

*UIC600 Microphone Display*



*Radio Display*

To set the **On/Off** for **Lone Worker**:

1. Select **LW ON** to turn on the Lone Worker.
2. Select **LW OFF** to turn off the Lone Worker.
3. Press the **B Button** to go back to the previous menu.

## DIAGNOSTICS

The **Diagnostics** option allows access to view the **Radio's Frequency** and **RSSI**.  
To access the **Diagnostics** option::

1. Select **Diagnostics** from the main menu.

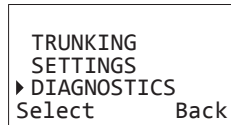

*UIC600 Microphone Display*



*Radio Display*

There are two options available for this feature:

- Frequency
- RSSI

### Frequency

The Frequency option displays the radio's current frequency.

To view radio **Frequency** details:

1. Select **Diagnostics** from the main menu.
2. Select **Frequency**.

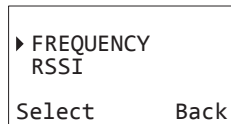

*UIC600 Microphone Display*



*Radio Display*

The following figure is an example of the radio frequency display on the controller microphone and local head.

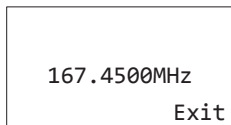

*UIC600 Microphone Display*



*Radio Display*

3. Press the **B Button** to exit.

## RSSI

The **RSSI** (Received Signal Strength Indication) option displays the received signal strength of the current channel. The signal strength is expressed in decibels (**dBm**). The higher the dBm number, the stronger the signal.

To view the radio **RSSI**:

1. Select **Diagnostics** from the main menu
2. Select **RSSI**.

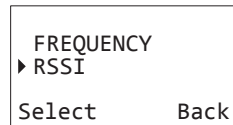

*UIC600 Microphone Display*

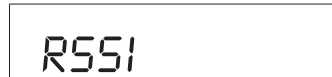

*Radio Display*

The figure belows is an example of the RSSI display on the controller microphone and the local head.

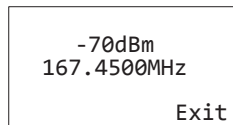

*UIC600 Microphone Display*



*Radio Display*

3. Press the **B Button** to exit.

## EMERGENCY MODES

Any programmable key can be configured to activate the **Emergency Mode**. Depending on how the local/ remote control head, or microphones are configured, a **Press** or **Hold** of the programmed key activates emergency mode.

**Page 6** in this manual displays the emergency button on the UIC600 controller microphone. Your dealer can configure the function of the button as required.

Contact your dealer for more information on the exact behaviour of emergency modes, and how to configure them on the radio.

## MENU TREE

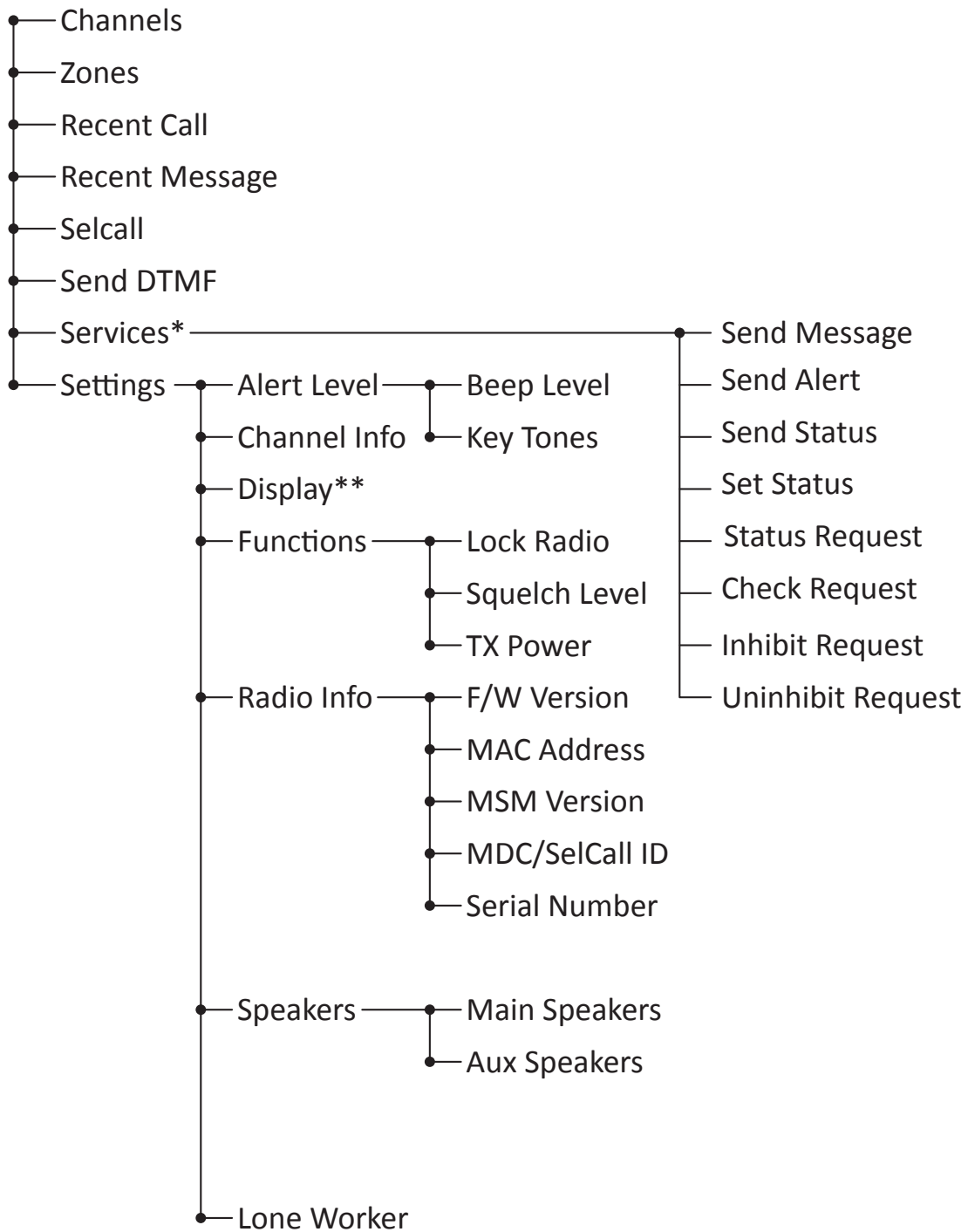

\* The 'Services' menu is displayed only when Digital Selcall (MDC1200) is enabled.

\*\* The 'Display' menu is displayed only on the local/remote control head.

### Copyright Notice:

---

GME Pty Ltd reserves all rights to this document and the information contained herein. Reproduction, use or disclosure to third parties without express permission is strictly prohibited.

© 2021 GME Pty Ltd, Sydney, Australia

### Interference with Vehicle Electronics

---

Some of the electronics in your vehicle may be susceptible to RF energy when your radio is transmitting. Examples of electronic devices in your vehicle that could be affected are anti-lock/anti-skid braking systems, cruise control systems and fuel injection systems. If your vehicle is fitted with any of these systems please consult your vehicle manufacturer to determine whether these systems are likely to be affected by your radio when it is transmitting. Careful selection of mounting locations and good installation techniques should generally minimise any interference to your vehicle electronics.

### Using the Radio in Explosive Atmospheres or Blasting Areas

---

Switch off your radio before entering any area where there may be inflammable gas, liquids or dust. An explosion could result in serious injury or death.

Switch off your radio when approaching a blasting area. Blasting areas are usually sign posted with instructions to users to turn off two way radios. Strong radio transmissions could ignite blasting caps resulting in an unscheduled explosion resulting in serious injury or death.

### Installation Guidelines

---

- Do not install the radio near an airbag or in an area where an airbag may deploy. If an airbag is obstructed by the radio, it may not deploy as expected. It could also propel the radio with enough force to cause serious injury.
- Avoid touching the heat sink at the rear of the radio while the radio is in use. The heat sink can become hot during prolonged use.
- Do not install the radio in front of a vehicle heater. The radio requires a cool airflow over the rear heat sink when transmitting to maintain efficiency.
- Do not make unapproved modifications to the radio. Such modifications could void the warranty and cause the radio to operate outside its approved specifications.

## Information Concerning UHF CB Radio:

---

### IMPORTANT

The use of the Citizen Band radio service is licensed in Australia by the ACMA Radio communications (Citizens Band Radio Stations) Class Licence and in New Zealand by the Ministry of Economic Development New Zealand (MED). A General User Radio Licence for Citizens Band radio and operation is subject to conditions contained in those licences. The class licence for users and equipment operating in the CB/PRS 477 MHz band has been amended. This radio meets the new 80 channel standard.

In simple terms the same amount of spectrum is available; however, radio transceivers can now operate in a narrower bandwidth and hence use less spectrum per channel. These radios are generally referred to as narrowband or 12.5 kHz radios. By using 12.5 kHz channel spacing instead of 25 kHz, the 40 channels originally allocated can now be expanded to 80 channels thereby

doubling the channel capacity and relieving congestion in the UHF CB/PRS band. Older 40 channel wideband radios will continue to operate on the original 40 channels, however they will not be able to converse on the newer channels 41 – 80. The newer narrowband radios will be able to converse with all older 40 channel wideband radios on all channels 1 – 40 as well as the newer channels allocated from 41 – 80.

The mixing of narrowband and wideband radios in the same spectrum may possibly cause operating issues of interference and varying levels of received volume. For example, when a new narrowband radio receives a transmission from an older wideband radio the speech may sound loud and distorted. Alternatively, when an older wideband radio receives a signal from a new narrowband radio, the speech may sound quiet. In each case, simply adjust your radio volume for best performance.

Depending on how close your receiving radio is to another transmitting radio, there might be interference from the transmitting radio if it is using a channel adjacent to the channel you are listening to. Simply switch up or down a few channels from the currently selected channel.

The above situations are not a fault of the radio but a symptom of operating wideband and narrowband radios in the same bandwidth. These minor issues should decrease over time as the population of wideband radios ages and decreases.

Further information and updates are available from the Australian Communications and Media Authority (ACMA) at [www.acma.gov.au](http://www.acma.gov.au) and the Ministry of Economic Development (MED), Radio Spectrum Management at [www.rsm.govt.nz](http://www.rsm.govt.nz).

### Repeater Channels:

---

Duplex operation allows the radio to transmit on a different frequency to that which it receives. This allows operation through repeater stations.

A repeater station consists of a linked transmitter/receiver combination installed in a prominent location. The repeater is designed to receive signals on a designated channel and retransmit them on another channel. Repeaters are usually mounted on hills or tall buildings. The increased elevation greatly improves both the receiving and transmitting range of the repeater allowing it to receive and retransmit signals to radios that would otherwise be out of range of each other.

Normally, UHF CB radios transmit and receive on the same frequency - known as Simplex operation. However, to communicate through repeaters, your radio must be able to transmit and receive on different channels - otherwise known as Duplex operation. Your radio may be programmed with a Talkaround key to allow you to choose between Duplex and Simplex operation.

The Duplex function can only be selected on UHF CB channels 1 - 8 and 41 - 48 as these are the channels that have been allocated for repeater use. When Duplex is selected, your radio receives on the selected channel (e.g. CH 1) but transmits 30 channels higher (CH 31). The repeater hears your signal on CH 31 and retransmits it on CH 1 for others to hear. Your CM40/CM50 radio allows you to enable or disable Duplex mode on individual repeater channels. In this way any repeater channels that are not being used with repeaters in your area can be used in Simplex mode for normal direct radio-to-radio communications. When a repeater channel is selected the Talkaround icon will be displayed when the channel is in Simplex mode and will be cleared when it is in Duplex mode.

**IMPORTANT:** UHF CB channels 1 - 8, 31 - 38, 41 - 48 and 71 - 78 should only be used in Simplex mode if there are no repeaters in or near your location that operate on the selected channel. In particular, avoid operating in Simplex mode on any of the repeater input channels 31 - 38 and 71 - 78 unless you are absolutely sure that there are no repeaters in range using that channel. Inadvertently transmitting on an active repeater input frequency in simplex mode could cause interference to other users on that repeater who might not be audible to your radio.

### **Selective Calling:**

---

When using selective calling on UHF CB channels, the ACMA CBRS Class License (Australia)/MED GURL (New Zealand) regulations require that the operator of a UHF CB station limit the cumulative transmission time of tones used for selective calling to a maximum of 3 seconds in any 60-second period. In the default configuration this will equate to placing no more than 6 selective calls in any 60-second period, but may change depending on the configuration of your radio.

### **Emergency Channels:**

---

The ACMA has allocated channels 5/35 for emergency use only. Channel 5 is the primary Simplex Emergency Channel. Where a channel 5 repeater is available, you should select Duplex on channel 5. Channel 35 is the input channel for the channel 5 repeater. Therefore channel 35 should also not be used for anything other than emergency transmissions.

### **Telemetry Channels:**

---

ACMA regulations have allocated channels 22 and 23 for telemetry-only applications and have prohibited the transmission of speech on these channels. Consequently the radio has a transmit inhibit applied to channels 22 and 23.

In the event that additional telemetry/telecommand channels are approved by the ACMA, these channels shall be added to those currently listed where voice transmission is inhibited. Currently, transmissions on channels 61, 62 and 63 are also inhibited and these channels are reserved for future allocation.

## GME WARRANTY AGAINST DEFECTS

This warranty against defects is given by GME Pty Ltd ACN 000 346 814 (We, us, our or GME). Our contact details are set out in clause 2.7. This warranty statement only applies to products purchased in Australia. Please contact your local GME distributor for products sold outside of Australia. Local distributor details at [www.gme.net.au/export](http://www.gme.net.au/export)

### 1. Consumer guarantees:

- 1.1 Our goods come with guarantees that cannot be excluded under the Australian Consumer Law. You are entitled to a replacement or refund for a major failure and for compensation for any other reasonably foreseeable loss or damage. You are also entitled to have the goods repaired or replaced if the goods fail to be of acceptable quality and the failure does not amount to a major failure.
- 1.2 To the extent we are able, we exclude all other conditions, warranties and obligations which would otherwise be implied.

### 2. Warranty against defects:

- 2.1 This Warranty is in addition to and does not limit, exclude or restrict your rights under the Competition and Consumer Act 2010 (Australia) or any other mandatory protection laws that may apply.
- 2.2 We warrant our goods to be free from defects in materials and workmanship for the warranty period (see warranty table) from the date of original sale (or another period we agree to in writing). Subject to our obligations under clause 1.2, we will at our option, either repair or replace goods which we are satisfied are defective. We warrant any replacement parts for the remainder of the period of warranty for the goods into which they are incorporated.
- 2.3 To the extent permitted by law, our sole liability for breach of a condition, warranty or other obligation implied by law is limited.
  - (a) In the case of goods we supply, to any one of the following as we decide –
    - (i) The replacement of the goods or the supply of equivalent goods.
    - (ii) The repair of the goods.
    - (iii) The cost of repairing the goods or of acquiring equivalent goods.
  - (b) In the case of services we supply, to any one of the following as we decide –
    - (i) The supplying of the services again
    - (ii) The cost of having the services supplied again.
- 2.4 For repairs outside the warranty period, we warrant our repairs to be free from defects in materials and workmanship for three months from the date of the original repair. We agree to re-repair or replace (at our option) any materials or workmanship which we are satisfied are defective.
- 2.5 We warrant that we will perform services with reasonable care and skill and agree to investigate any complaint regarding our services made in good faith. If we are satisfied that the complaint is justified, and as our sole liability to you under this warranty (to the extent permitted at law), we agree to supply those services again at no extra charge to you.
- 2.6 To make a warranty claim you must before the end of the applicable warranty period (see warranty table), at your own cost, return the goods you allege are defective, provide written details of the defect, and give us an original or copy of the sales invoice or some other evidence showing details of the transaction.



Before returning any goods you will be required to follow the available options:

Contact our Customer Support Team on 1300 463 463 or techsupport@gme.net.au.

A customer support team member will troubleshoot and validate if your product is faulty. If so, they will email you a product RMA (Return Material Authorisation).

Products that are authorised to be returned to GME must include the following:

RMA form (Return Material Authorisation)

A copy of your proof of purchase, the faulty product, including all accessories

## 2.7 Send your claim to:

### Australia

#### GME Pty Ltd

17 Gibbon Rd, Winston Hills

NSW 2153, Australia

T: (02) 8867 6000 | F: (02) 8867 6199

E: servadmin@gme.net.au

RMA Request: rma@gme.net.au

### New Zealand

#### GME Communications (NZ) Limited

Unit A, 11 Echelon Place, East Tamaki

Auckland 2013, New Zealand

T: (09) 274 0955 | F: (09) 274 0959

E: nzbranch@gme.net.au

RMA Request: nzrma@gme.net.au

**2.8** If we determine that your goods are defective, we will pay for the cost of returning the repaired or replaced goods to you, and reimburse you for your reasonable expenses of sending your warranty claim to us.

## 3. What this warranty does not cover:

**3.1** This warranty will not apply in relation to:

- (a) Goods modified or altered in any way.
- (b) Defects and damage caused by use with non GME products.
- (c) Repairs performed other than by our authorised representative.
- (d) Defects or damage resulting from misuse, accident, impact or neglect.
- (e) Goods improperly installed or used in a manner contrary to the relevant instruction manual; or
- (f) Goods where the serial number has been removed or made illegible.

## 4. Warranty period:

**4.1** We provide the following warranty on GME Commercial Products. No repair or replacement during the warranty period will renew or extend the warranty period past the period from original date of purchase.

Product Type	Warranty Period
CM40 & CM50 Radio	5 Years
UIC & Accessories	1 Year





[gmecommercial.com.au](http://gmecommercial.com.au)

GME Pty Ltd.

17 Gibbon Road, Winston Hills NSW 2153, Australia  
P/N: N/A D/N: 52250-2

MARCH 2023